

HPRC[®]



2018
CASES WORKBOOK

H P R C C A S E S
MADE IN ITALY
M A N U F A C T U R E D



Our Brand

We're about happiness by cases. It means we're not just in the business of creating protective cases, even though that is what we do. Our everyday commitment is designed to make people happy.

From an ever-growing collection of innovative products to our passionate team who makes it happen, it's all about happiness.

Our Products

We're always looking for what's next. We're constantly innovating our original designed form and function, proving a fresh approach to the art of cases. By incorporating different styles, top quality materials and eye-catching patterns into our design, we make more than a case. We make a statement.

Our History

HPRC cases were born in 2006 with one simple premise: we can design a better case. In almost 10 years HPRC has grown into a successful international business, teaming up with important companies and partners. Our products can be found in 76 countries and have garnered top awards and praise. As we grow, our entrepreneurial spirit continues to drive the HPRC culture. After all, it's what helped us build one of the world's best hard cases brand.

Ultralight. Watertight. Smart Cases.

HPRC cases can be used for all sorts of applications and different areas: photography, industrial, military, nautical, police and many others. HPRC provides total protection to the carried equipment against dust, water, impacts and corrosion for chemical agents.



Outdoor | Diving | Marine



Photo | Video



Industrial | Electronic | It

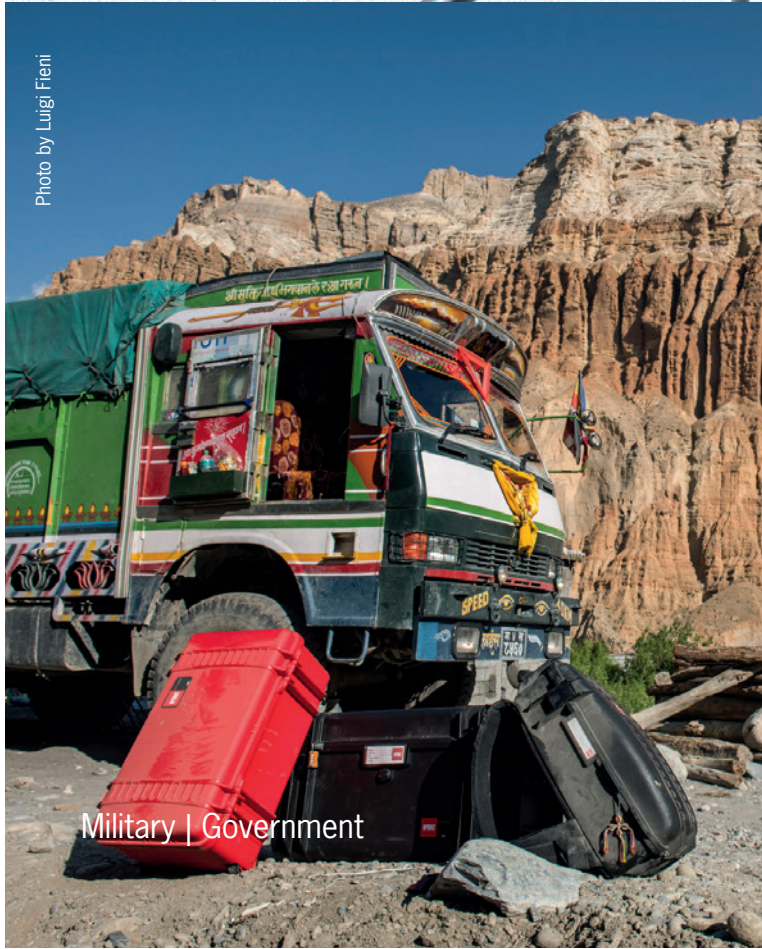

Photo by Luigi Fieni

Military | Government



Photo by Flavio Oliva

Fire | Emergency | Medical

Highlights

HPRC2550W

V.2017

SECOND SKIN



The new **HPRC2550W** is the upgrade to our most popular case.

- Now added FLAT top handle
- Improved Trolley System with one-handed thumb release
- Customizable wheel hubs (logos/colors)
- New wider latched with Soft-Touch overmold
- New and improved Valance



More info at page: 26

Second Skin is the new and revolutionary protective system thought by **HPRC** to protect your equipment;



Like a real "second skin" it's made by a thermoforming material that allows you to exploit the maximum internal volume of the case maintaining an optimal protection. A system that increases the 20% the internal usable

volume, with 70% weight less than the current soft deck. Second Skin weighs only 350 grams and, thanks to the modular dividers, you can always create different configurations according to your needs.

Special soft cases



HPRC also produces different lines of soft cases and backpacks specifically designed to carry and protect the most popular drones of the market.



Committments

Our committment to you:

1.UNDERSTAND the problems of your market and your specific requirements. Through our expert knowledge of technological and economic trends we can offer an uncompromisingly individual approach to each customer.

2.FIND a transport solution tailored to your requirements. Our extensive cases range, our custom solutions that go far beyond our product offer, our team that assists you in selecting the case that is best suited to your own needs, are our core strengths.

3.LISTEN to and take account of your comments, through our network of experts and our frequent satisfaction surveys.

4.BE incessantly innovative and competitive in the professional cases market.

HPRC: innovation, technology and design.

Most of hard watertight cases are made in standard pp: our r&d department has developed an enhanced compound, still based on pp, now balanced with additional high performance resins. Ttx01® allows to produce cases which are lighter in weight and stronger in robustness. The special mix we added makes the HPRC shell thinner and more elastic, increasing therefore the shockproof degree and the lightweight. On the top of that, maintaining pp characteristics, HPRC cases are acidproof, scratchproof, able to resist to extreme weather conditions and temperature changes (all products are tested from - 40° c up to 80°c).



pole: ALU



body: TTX01® hardware: steel



wheels: PA66+PUR



handle: PP+SEBS



latches: POM



ext.handle: PA66GF30

Do you want to know more?
Please contact our technical team: tech@hprc.it



HPRC life time warranty: HPRC products have been built to rigorous standards of quality and are guaranteed against all defects in materials and workmanship for the whole life of the case.



Airex is the new automatic purge valve that is auto press release adjusted to changing environments automatically.

The attention and respect toward the environment and the commitment to an eco-sustainable future are important values for HPRC

 we case in **green.**

Our commitment starts from the design phase of the product, and involves all the production stages including the management of the impact of the product's end of life. All shells and components of HPRC cases are 100% recyclable: the production and transformation discards are infact reintegrated in the production cycle. The high resistance of the patented material ttx01® allows to use the HPRC cases longer than any other case, reducing therefore the emissions of CO2 due to the production

and distribution. The constant quest for suppliers complying with iso 14000 or emas certification and which are geographically close to our company is a contribute to reduce the environmental impact and represents a challenge in a world where firms usually aim only for low price suppliers not considering their possibly higher environmental impact. Moreover HPRC adopts renewable sources plants for energy production to cover the energetic needs.

Standard cases

HPRC cases are available with a standard setup if you don't need any special customization regarding the shell or the interior foam. Here are the 5 possible standard configurations.

* CUBED FOAM - USA: F



* EMPTY - USA: E



* SOFT PADDED OPEN DECK + DIVIDERS - USA: DK



* INTERIOR BAG - USA: IC



* SECOND SKIN - USA: SK



* PANEL FRAME MOUNTING SYSTEM AVAILABLE

Oem cases

We are cases producers,
if you do not find the right size or best liked design
we will make a customized case for you

1. Product inquiry >>>> Mold + price offer
2. Contract signing >>>> Design drawing
3. Client confirmation >>>> Mold making
4. Sample checking >>>> Production arrangement

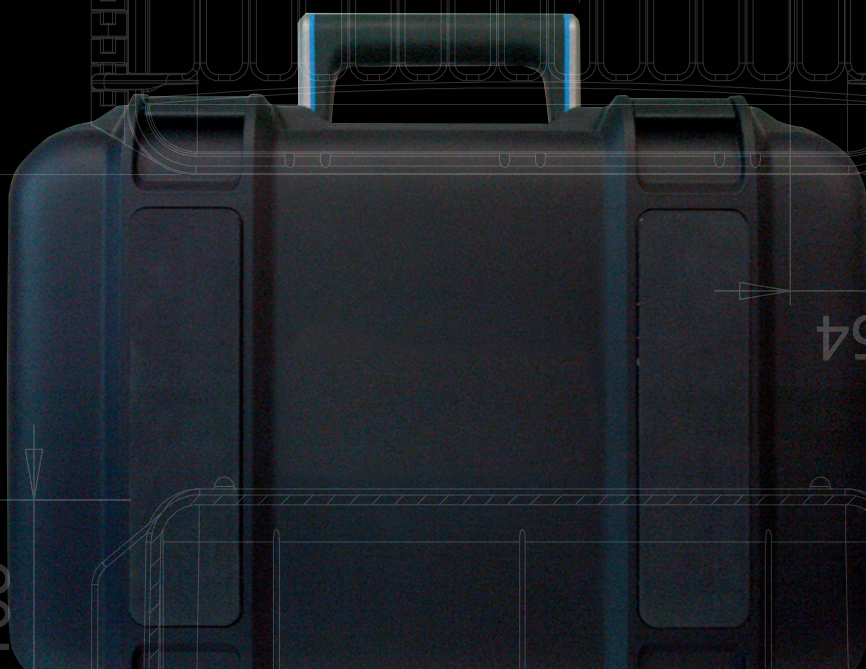

Custom fit cases

Customization concerns: color, printing, adhesive, foam inlay (die cut, water cut, milled, moulded), thermoformed inlay, lid panels and organizer, extra working on the cases shell (holes, external applications) keeping the water tightness.



HIGH VISIBILITY INLAYS

A special high visibility inlay can be designed in order to avoid forgetting equipment on the field after use.



CUSTOMIZED LAYOUT

We give customers different equipment layouts options in order to optimize space and handiness.



CUSTOMIZED COVERS

Customization also includes the possibility to design solutions in order to use the cover as a glove compartment. We can provide organizers, special tools addition, shell modifications and custom colors.



SHELL CUSTOMIZATION

HPRC customization service also provides shell customization, including holes for external connections.

HPRC panel frame accessory (HPRCPF) allows customers to install a control panel into the case, ensuring a perfect fit.

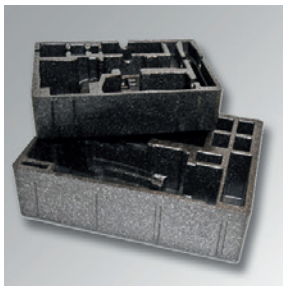

INJECTION INLAYS

The custom inlay made in expanded polypropylene of different densities guarantees a perfect protection and a professional look to the case. Our service includes the initial study of the mould and goes through the prototype phase and final production.



MILLED FOAMS

The milling technology allows to get one piece inlays with many different depths.

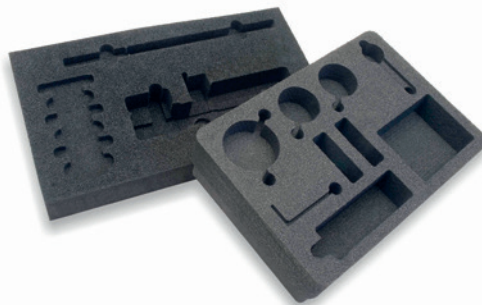

WATER CUTTING TECHNOLOGY FOAMS

Expanded polyethylene foams are available in various densities (Kg/m³), resistance to compression (kPa) and resistance to different temperature ranges (°C). These foams, produced with water cutting technology, guarantee a good protection and allow a wide range of customizations.

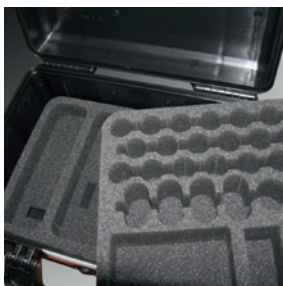

MULTY LAYER

A multi layer case is a handy solution, especially when equipment is made of many small and different parts that must be stored and protected into one case only.

HPRC 1100



* open cases images reflect the different HPRC cases internal options

TECHNICAL FEATURES

Dimension:

internal dimension 57x58x25,5(mm) - 2.24x2.28x1.00(in)
external dimension 69x80x32(mm) - 2.72x3.15x1.26(in)



lid: 12,8(mm) - 0.50(in) bottom: 12,7(mm) - 0.50(in)

Weight:

empty: 0,04kg - 0.09lbs

available empty or with memory card storage

Temperature rating:

Minimum Maximum
-40°C -40°F +80°C +176°F

Colors:

Black - Ferrari red

TECHNICAL DRAWING

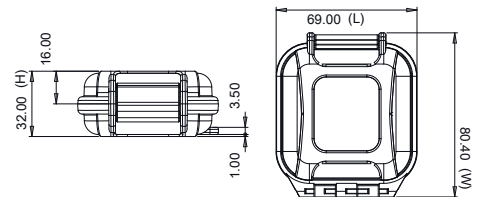

			<div style="display: flex; justify-content: space-between; align-items: center;"> <div style="text-align: center;"> </div> <div style="text-align: center;"> </div> <div style="text-align: center;"> </div> <div style="text-align: center;"> </div> </div> <div style="display: flex; justify-content: space-between; margin-top: 10px;"> <div style="width: 45%;"> <p>APPROVALS ATA 300 IP67 STANAG 4280 DS 81-41</p> </div> <div style="width: 45%;"> <p>TEST DROP IMPACT HANDLE WATERTIGHT INTEGRITY UV COLOR AND MATERIAL PROTECTION</p> </div> </div> <div style="text-align: right; margin-top: 10px;"> <p>volume in litres </p> </div>
* memory card case	* empty case		

FEATURES

- Removable multiformat memory card holder
- Accepted card Formats:
 - 2 of SD cards
 - 1 of XQD card
 - 1 of CF card
- Full/empty indicator



Both models with our trademark
"Full - Empty" switch: just flip the arrow towards the desired E-F position and get straight access to your cards.

* open cases images reflect the different HPRC cases internal options



TECHNICAL FEATURES

Dimension:

internal dimension 116x67x25,5(mm) - 4.57x2.64x1.00(in)
external dimension 127x90x32(mm) - 5.00x3.54x1.26(in)



lid: 12,8(mm) - 0.50(in) bottom: 12,7(mm) - 0.50(in)

Weight:

empty: 0,09kg - 0.19lbs

available empty or with memory card storage

Temperature rating:

Minimum Maximum
-40°C -40°F +80°C +176°F

Colors:

Black - Ferrari red

TECHNICAL DRAWING

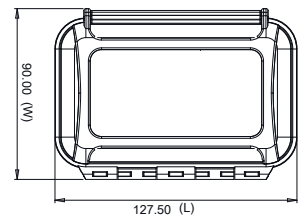
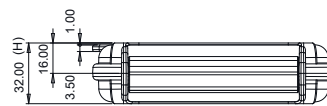

* cubed foam



* memory card case



* memory Card Case for video



APPROVALS
ATA 300
IP67
STANAG 4280
DS 81-41

TEST
DROP
IMPACT
HANDLE
WATERTIGHT INTEGRITY
UV COLOR AND MATERIAL
PROTECTION



FEATURES

- Removable multiformat memory card holder
- Accepted card Formats:
 - 8 of SD cards
 - 4 of XQD cards
 - 4 of CF cards
- Full/empty indicator



HPRC 2100



* open cases images reflect the different HPRC cases internal options

TECHNICAL FEATURES

Dimension:

internal dimension 210x145x94(mm) - 8.27x5.71x3.70(in)
external dimension 235x196x110(mm) - 9.25x7.72x4.33(in)



lid: 18(mm) - 0.71(in) bottom: 76(mm) - 2.99(in)

Weight:

empty: 0,76kg - 1.68lbs
with cubed foam: 0,84kg - 1.85lbs

Temperature rating:

Minimum Maximum
-40°C -40°F +80°C +176°F

Colors:

Black - Orange - Ferrari red - Electric blue

TECHNICAL DRAWING

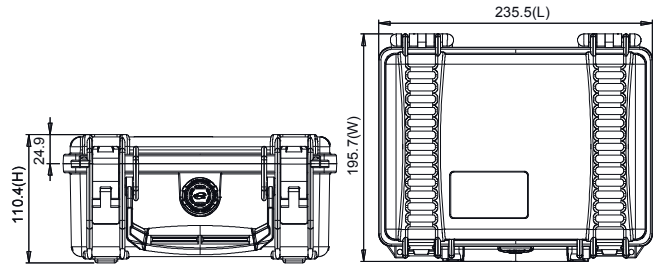

* cubed foam

* interior bag



APPROVALS
ATA 300
IP67
STANAG 4280
DS 81-41

TEST
DROP
IMPACT
HANDLE
WATERTIGHT INTEGRITY
UV COLOR AND MATERIAL
PROTECTION



ACCESSORIES

HPRCCUB2100
CUBED FOAM
USA:HPRCFO (foam only)

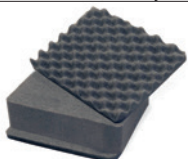

HPRCLO708TSA-1
PADLOCK - TSA



HPRCBAG2100
INTERIOR BAG
USA:HPRCIC (internal case)



HPRCPF-001-01
PANEL FRAME
(panel not included)



* open cases images reflect the different HPRC cases internal options



TECHNICAL FEATURES

Dimension:

internal dimension 236x182x108(mm) - 9.29x7.17x4.25(in)
external dimension 258x230x123(mm) - 10.16x9.06x4.84(in)



lid: 29(mm) - 1.14(in) bottom: 79(mm) - 3.11(in)

Weight:

empty: 0,87kg - 1.92lbs
with cubed foam: 1,08kg - 2.38lbs

Temperature rating:

Minimum -40°C -40°F Maximum +80°C +176°F

Colors:

Black

TECHNICAL DRAWING

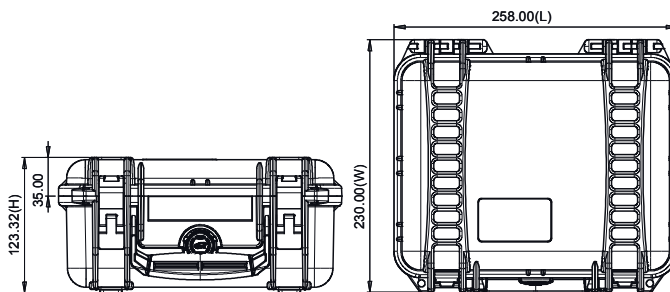

* cubed foam



* interior bag



APPROVALS
ATA 300
IP67
STANAG 4280
DS 81-41

TEST
DROP
IMPACT
HANDLE
WATERTIGHT INTEGRITY
UV COLOR AND MATERIAL
PROTECTION



ACCESSORIES

HPRCCUB2200
CUBED FOAM
USA:HPRCFO (foam only)

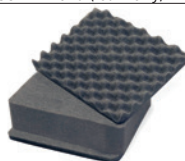

HPRCLO708TSA-1
PADLOCK - TSA



HPRCBAG2200
INTERIOR BAG
USA:HPRCIC (internal case)



HPRCPF-002-01
PANEL FRAME
(panel not included)



HPRC 2250



* open cases images reflect the different HPRC cases internal options

TECHNICAL FEATURES

Dimension:

internal dimension 236x182x155(mm) - 9.29x7.17x6.10(in)
external dimension 258x230x170(mm) - 10.16x9.06x6.69(in)



lid: 29(mm) - 1.14(in) bottom: 126(mm) - 4.96(in)

Weight:

empty: 1,00kg - 2.20lbs
with cubed foam: 1,35kg - 2.97lbs

Temperature rating:

Minimum Maximum
-40°C -40°F +80°C +176°F

Colors:

Black

TECHNICAL DRAWING

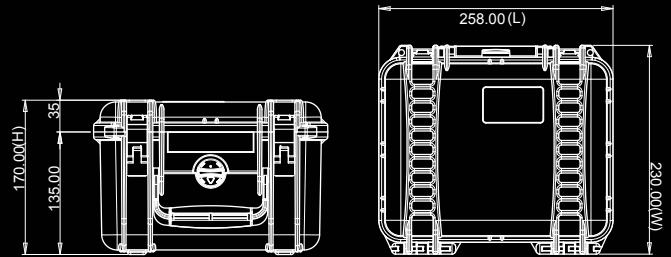

* cubed foam

* interior bag



APPROVALS
ATA 300
IP67
STANAG 4280
DS 81-41

TEST
DROP
IMPACT
HANDLE
WATERTIGHT INTEGRITY
UV COLOR AND MATERIAL
PROTECTION



ACCESSORIES

<p>HPRCCUB2250 CUBED FOAM USA:HPRCFO (foam only)</p>	<p>HPRCLO708TSA-1 PADLOCK - TSA</p>	<p>HPRCBAG2250 INTERIOR BAG USA:HPRCIC (internal case)</p>	<p>HPRCPF-002-01 PANEL FRAME (panel not included)</p>

* open cases images reflect the different HPRC cases internal options



TECHNICAL FEATURES

Dimension:

internal dimension 304x231x137(mm) - 11.97x9.09x5.39(in)
external dimension 335x289x155(mm) - 13.19x11.38x6.10(in)



lid: 31(mm) - 1.22(in) bottom: 106(mm) - 4.17(in)

Weight:

empty: 1,67kg - 3.68lbs
with cubed foam: 1,90kg - 4.19lbs

Temperature rating:

Minimum -40°C -40°F Maximum +80°C +176°F

Colors:

Black - Orange - Ferrari red - Electric blue

TECHNICAL DRAWING

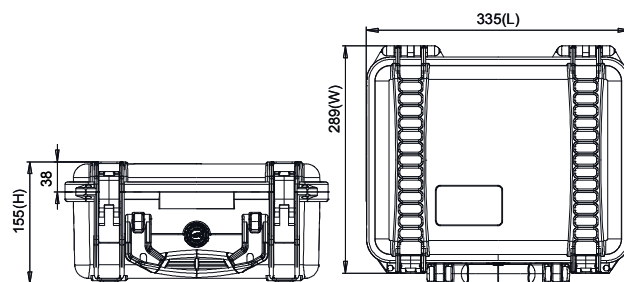

* cubed foam



* interior bag



APPROVALS
ATA 300
IP67
STANAG 4280
DS 81-41

TEST
DROP
IMPACT
HANDLE
WATERTIGHT INTEGRITY
UV COLOR AND MATERIAL
PROTECTION



ACCESSORIES

HPRCCUB2300
CUBED FOAM
USA:HPRCFO (foam only)

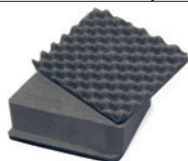

HPRCLO708TSA-1
PADLOCK - TSA



HPRCBAG2300
INTERIOR BAG
USA:HPRCIC (internal case)



HPRCPF-003-01
PANEL FRAME
(panel not included)



HPRC 2350



* open cases images reflect the different HPRC cases internal options

TECHNICAL FEATURES

Dimension:

internal dimension 340x235x99(mm) - 13.38x9.25x3.90(in)
external dimension 365x290x115(mm) - 14.37x11.42x4.53(in)



lid: 29(mm) - 1.14(in) bottom: 70(mm) - 2.75(in)



Weight:

empty: 1.48kg - 3.25lbs
with cubed foam: 1.66kg - 3.65lbs

Temperature rating:

Minimum Maximum
-40°C -40°F +80°C +176°F

Colors:

Black

TECHNICAL DRAWING

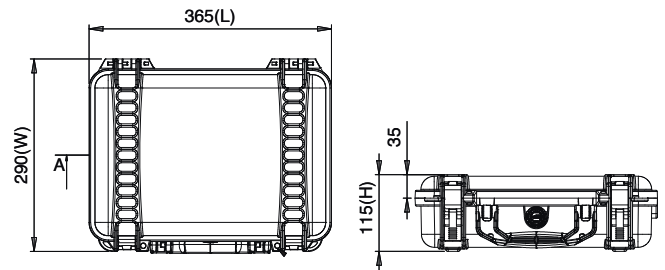

* cubed foam



APPROVALS
ATA 300
IP67
STANAG 4280
DS 81-41

TEST
DROP
IMPACT
HANDLE
WATERTIGHT INTEGRITY
UV COLOR AND MATERIAL
PROTECTION



ACCESSORIES

HPRCCF2350
CUBED FOAM
USA:HPRCFO (foam only)

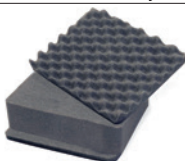

HPRCLO708TSA-1
PADLOCK - TSA



HPRCBAG2350
INTERIOR BAG
USA:HPRCIC (internal case)





PRADA
DAILY PROTECTIVE BAG
AA
86

PRADA
DAILY PROTECTIVE BAG
AA
85

PRADA
DAILY PROTECTIVE BAG
AA
84

HPRC 2850W
PRADA
DAILY PROTECTIVE BAG
D6
Q4

PRADA
DAILY PROTECTIVE BAG
03 J180114
Bc
1
The 1st of January 2014 - 6pm
06:00am
06:00am
06:00am

PRADA
DAILY PROTECTIVE BAG
06

PRADA
DAILY PROTECTIVE BAG
03 J180114

PRADA
DAILY PROTECTIVE BAG
D6
Q4

PRADA

PRADA

HPRC 2400



* open cases images reflect the different HPRC cases internal options

TECHNICAL FEATURES

Dimension:

internal dimension 380x266x152(mm) - 14.96x10.47x5.98(in)
external dimension 405x330x170(mm) - 15.94x12.99x6.69(in)

lid: 45(mm) - 1.77(in) bottom: 107(mm) - 4.21(in)

Weight:

empty: 2,05kg - 4.52lbs
with cubed foam: 2,38kg - 5.25lbs

Temperature rating:

Minimum Maximum
-40°C -40°F +80°C +176°F

Colors:

Black - Orange - Ferrari red - Electric blue



TECHNICAL DRAWING

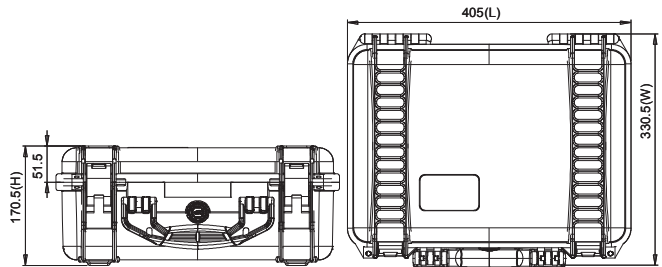

* cubed foam

* interior bag



APPROVALS
ATA 300
IP67
STANAG 4280
DS 81-41

TEST
DROP
IMPACT
HANDLE
WATERTIGHT INTEGRITY
UV COLOR AND MATERIAL
PROTECTION



ACCESSORIES

HPRCCUB2400 CUBED FOAM USA:HPRCFO (foam only)	HPRCLO708TSA-1 PADLOCK - TSA	HPRCBAG2400 INTERIOR BAG USA:HPRCIC (internal case)	HPRCORG2400 LID ORGANIZER	HPRCPF-004-01 PANEL FRAME (panel not included)

* open cases images reflect the different HPRC cases internal options



TECHNICAL FEATURES

Dimension:

internal dimension 409x306x175(mm) - 16.10x12.05x6.89(in)
external dimension 434x371x193(mm) - 17.09x14.61x7.60(in)



lid: 70(mm) - 2.76(in) bottom: 105(mm) - 4.14(in)

Weight:

empty: 2,60kg - 5.73lbs
with cubed foam: 3,14kg - 6.92lbs

Temperature rating:

Minimum Maximum
-40°C -40°F +80°C +176°F

Colors:

Black

TECHNICAL DRAWING

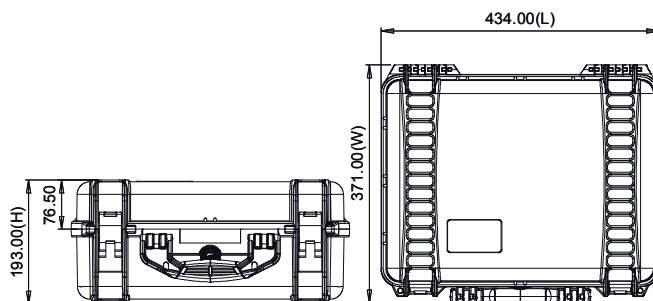

* cubed foam



* interior bag



APPROVALS
ATA 300
IP67
STANAG 4280
DS 81-41

TEST
DROP
IMPACT
HANDLE
WATERTIGHT INTEGRITY
UV COLOR AND MATERIAL
PROTECTION



ACCESSORIES

HPRCCUB2460
CUBED FOAM
USA:HPRCFO (foam only)

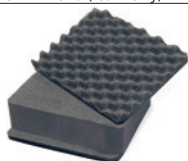

HPRCLO708TSA-1
PADLOCK - TSA



HPRCBAG2460
INTERIOR BAG
USA:HPRCIC (internal case)



HPRCORG2460
LID ORGANIZER



HPRCPF-005-01
PANEL FRAME
(panel not included)



HPRC 2500



* open cases images reflect the different HPRC cases internal options

TECHNICAL FEATURES

Dimension:
internal dimension 450x323x175(mm) - 17.72x12.72x6.89(in)
external dimension 478x390x194(mm) - 18.82x15.35x7.64(in)

lid: 46(mm) - 1,81(in) bottom: 129(mm) - 5.08(in)

Weight:
empty: 3,15kg - 6.94lbs
with cubed foam: 3,71kg - 8.18lbs

Temperature rating:
Minimum -40°C -40°F Maximum +80°C +176°F

Colors:
Black - Orange - Ferrari red - Electric blue



TECHNICAL DRAWING

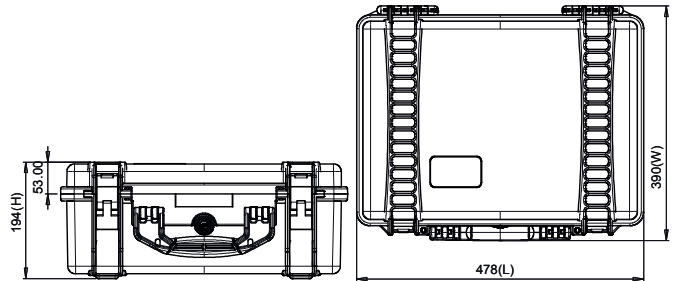

* cubed foam * interior bag * soft padded open deck + dividers



APPROVALS
ATA 300
IP67
STANAG 4280
DS 81-41

TEST
DROP
IMPACT
HANDLE
WATERTIGHT INTEGRITY
UV COLOR AND MATERIAL
PROTECTION



ACCESSORIES

<p>HPRCCUB2500 CUBED FOAM USA:HPRCFO (foam only)</p> 	<p>HPRCLO708TSA-1 PADLOCK - TSA</p> 	<p>HPRCBAG2500 INTERIOR BAG USA:HPRCIC (internal case)</p> 	<p>HPRCORG2500 LID ORGANIZER</p> 	<p>HPRCPF-006-01 PANEL FRAME (panel not included)</p> 	<p>HPRCSFD2500 SOFT PADDED OPEN DECK + DIVIDERS USA: HPRCDK (divider kit)</p> 
---	--	---	---	--	--

* open cases images reflect the different HPRC cases internal options



TECHNICAL FEATURES

Dimension:

internal dimension 513x288x132(mm) - 20.20x11.34x5.20(in)
external dimension 540x350x153(mm) - 21.26x13.78x6.02(in)



lid: 46(mm) - 1.81(in) bottom: 86(mm) - 3.25(in)

Weight:

empty: 3,20kg - 7.05lbs
with cubed foam: 3,26kg - 7.19lbs

Temperature rating:

Minimum Maximum
-40°C -40°F +80°C +176°F

Colors:

Black

TECHNICAL DRAWING

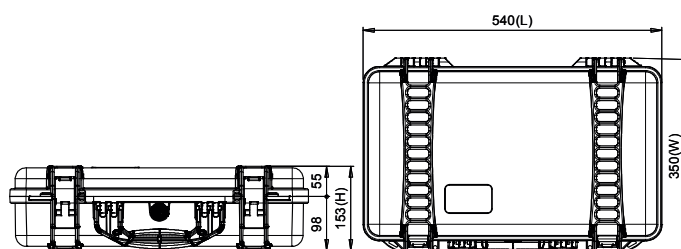

* cubed foam



* soft padded open deck + dividers



* interior bag



APPROVALS
ATA 300
IP67
STANAG 4280
DS 81-41

TEST
DROP
IMPACT
HANDLE
WATERTIGHT INTEGRITY
UV COLOR AND MATERIAL
PROTECTION



ACCESSORIES

HPRCCUB2530
CUBED FOAM
USA:HPRCFO (foam only)



HPRCLO708TSA-1
PADLOCK - TSA



HPRCSTRAP



HPRCORG2530
LID ORGANIZER



HPRCSFD2530 SOFT PADDED
OPEN DECK + DIVIDERS USA:
HPRCDK (divider kit)



HPRCBAG2530
INTERIOR BAG
USA:HPRCIC (internal case)



HPRC 2550W



* open cases images reflect the different HPRC cases internal options

TECHNICAL FEATURES

Dimension:

internal dimension 513x288x200(mm) - 20.19x11.34x7.87(in)
external dimension 549x346x236(mm) - 21.61x13.62x9.29(in)

lid: 48(mm) - 1.88(in) bottom: 152(mm) - 5.98(in)

Weight:

empty: 4.35kg - 9.57lbs

Temperature rating:

Minimum Maximum
-40°C -40°F +80°C +176°F

Colors:

Black - Orange - Ferrari red - Electric blue



TECHNICAL DRAWING

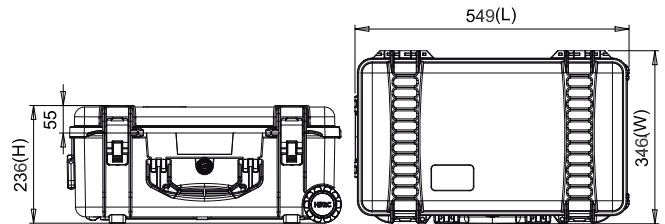

* cubed foam	* interior bag	* second skin	APPROVALS ATA 300 IP67 STANAG 4280 DS 81-41
			TEST DROP IMPACT HANDLE WATERTIGHT INTEGRITY UV COLOR AND MATERIAL PROTECTION
			volume in litres wheeled

ACCESSORIES

HPRCCUB2550W CUBED FOAM USA:HPRCFO (foam only)	HPRCLO708TSA-1 PADLOCK - TSA	HPRCBAG2550W-01 INTERIOR BAG USA:HPRCIC (internal case)	HPRCORG-004-01 LID ORGANIZER	HPRCSSK2550W-01 SECOND SKIN	

* open cases images reflect the different HPRC cases internal options



TECHNICAL FEATURES

Dimension:

internal dimension 390x310x89(mm) - 15.35x12.20x3.50(in)
external dimension 410x359x110(mm) - 16.14x14.13x4.33(in)

lid: 44(mm) - 1.73(in) bottom: 45(mm) - 1.77(in)

Weight:

empty: 2,40kg - 5.29lbs
with cubed foam: 2,57kg - 5.67lbs

Temperature rating:

Minimum -40°C -40°F Maximum +80°C +176°F

Colors:

Black



TECHNICAL DRAWING

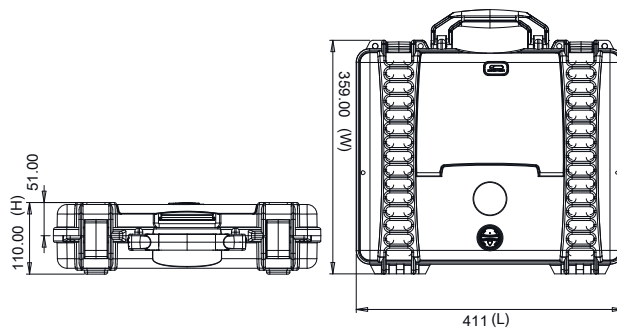

* cubed foam



* interior bag



APPROVALS
ATA 300
IP67
STANAG 4280
DS 81-41

TEST
DROP
IMPACT
HANDLE
WATERTIGHT INTEGRITY
UV COLOR AND MATERIAL
PROTECTION



ACCESSORIES

HPRCCUB2580
CUBED FOAM
USA:HPRCF0 (foam only)

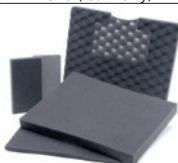

HPRCLO708TSA-1
PADLOCK - TSA



HPRCSTRAP



HPRCORG2580
LID ORGANIZER



HPRC 2600



* open cases images reflect the different HPRC cases internal options

TECHNICAL FEATURES

Dimension:

internal dimension 482x358x198(mm) - 18.97x14.09x7.79(in)
external dimension 543x419x218(mm) - 21.37x16.49x8.58(in)

lt34

lid: 46(mm) - 1.81(in) bottom: 152(mm) - 5.98(in)

Weight:

empty: 4,25kg - 9.37lbs
with cubed foam: 5,05kg - 11.13lbs

Temperature rating:

Minimum Maximum
-40°C -40°F +80°C +176°F

Colors:

Black - Orange - Ferrari red - Electric blue

TECHNICAL DRAWING

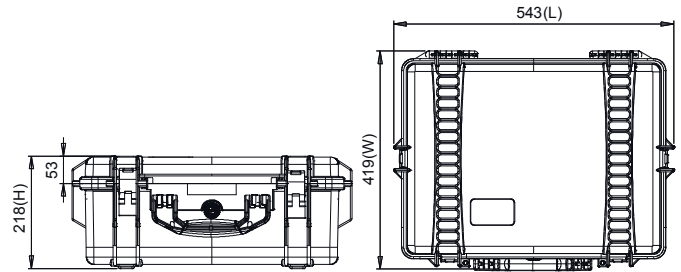

* cubed foam	* interior bag	* second skin	APPROVALS ATA 300 IP67 STANAG 4280 DS 81-41 TEST DROP IMPACT HANDLE WATERTIGHT INTEGRITY UV COLOR AND MATERIAL PROTECTION W wheeled

ACCESSORIES

HPRCCUB2600 CUBED FOAM USA:HPRCFO (foam only)	HPRCLO708TSA-1 PADLOCK - TSA	HPRCBAG2600 INTERIOR BAG USA:HPRCIC (internal case)	HPRCORG2600 LID ORGANIZER	HPRCPF-007-01 PANEL FRAME (panel not included)	HPRCSSK2600-01 SECOND SKIN

HPRC 2600W

* open cases images reflect the different HPRC cases internal options



TECHNICAL FEATURES

Dimension:

internal dimension 482x358x218(mm) - 18.98x14.09x8.58(in)
external dimension 546x423x250(mm) - 21.05x16.65x9.84(in)

lt38

lid: 46(mm) - 1.81(in) bottom: 172(mm) - 6.77(in)

W

Weight:

empty: 6,05kg - 13.34lbs
with cubed foam: 6,97kg - 15.37lbs

Temperature rating:

Minimum Maximum
-40°C -40°F +80°C +176°F

Colors:

Black - Orange - Electric blue

TECHNICAL DRAWING

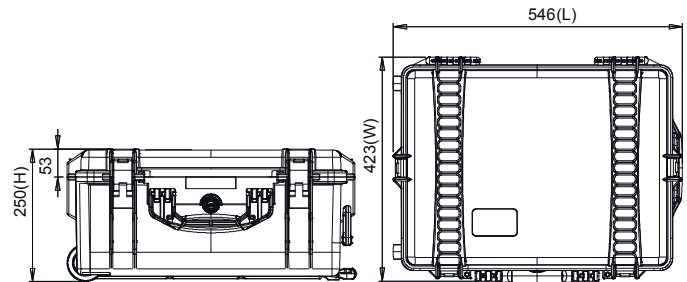

* cubed foam

* interior bag

* second skin



APPROVALS
ATA 300
IP67
STANAG 4280
DS 81-41

TEST
DROP
IMPACT
HANDLE
WATERTIGHT INTEGRITY
UV COLOR AND MATERIAL
PROTECTION



ACCESSORIES

HPRCCUB2600W
CUBED FOAM
USA:HPRCFO (foam only)

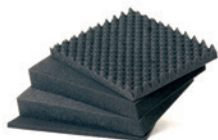

HPRCLO708TSA-1
PADLOCK - TSA



HPRCBAG600W
INTERIOR BAG
USA:HPRCIC (internal case)



HPRCORG2600W
LID ORGANIZER



HPRCPF-008-01
PANEL FRAME
(panel not included)



HPRCSSK2600W-01
SECOND SKIN



SECOND SKIN

HPRC 2700



* open cases images reflect the different HPRC cases internal options

TECHNICAL FEATURES

Dimension:

internal dimension 555x459x205(mm) - 21.85x18.07x8.07(in)
external dimension 617x525x227(mm) - 24.29x20.67x8.94(in)



lid: 45(mm) - 1.77(in) bottom: 160(mm) - 6.29(in)

Weight:

empty: 5,55kg - 12.24lbs
with cubed foam: 6,71kg - 14.79lbs

Temperature rating:

Minimum Maximum
-40°C -40°F +80°C +176°F

Colors:

Black - Orange - Ferrari red

TECHNICAL DRAWING

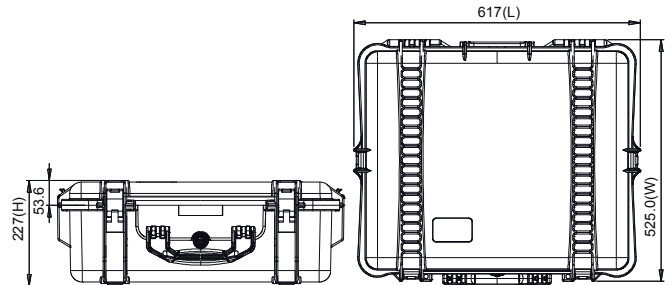

* cubed foam	* interior bag	* soft padded open deck + dividers	APPROVALS ATA 300 IP67 STANAG 4280 DS 81-41
			TEST DROP IMPACT HANDLE WATERTIGHT INTEGRITY UV COLOR AND MATERIAL PROTECTION
			 volume in litres wheeled

ACCESSORIES

HPRCCUB2700 CUBED FOAM USA:HPRCFO (foam only)	HPRCLO708TSA-1 PADLOCK - TSA	HPRCBAG2700 INTERIOR BAG USA:HPRCIC (internal case)	HPRCORG2700 LID ORGANIZER	HPRCSFD2700 SOFT PADDED OPEN DECK + DIVIDERS USA: HPRCDK (divider kit)

* open cases images reflect the different HPRC cases internal options

HPRC 2700W



TECHNICAL FEATURES

Dimension:

internal dimension 555x459x256(mm) - 21.85x18.07x10.08(in)
external dimension 620x525x280(mm) - 24.41x20.67x11.02(in)

lit 65

lid: 45(mm) - 1.77(in) bottom: 211(mm) - 8.30(in)

W

Weight:

empty: 8,30kg - 18.30lbs
with cubed foam: 9,07kg - 19.99lbs

Temperature rating:

Minimum Maximum
-40°C -40°F +80°C +176°F

Colors:

Black - Orange - Ferrari red

TECHNICAL DRAWING

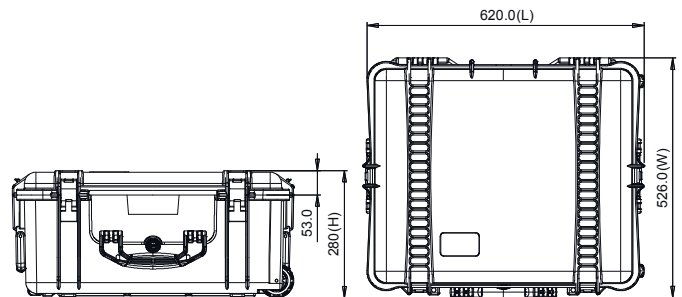

		 NEW				
* cubed foam	* interior bag	* second skin	APPROVALS ATA 300 IP67 STANAG 4280 DS 81-41		TEST DROP IMPACT HANDLE WATERTIGHT INTEGRITY UV COLOR AND MATERIAL PROTECTION	

volume in litres
W
wheeled

ACCESSORIES

HPRCCUB2700W CUBED FOAM USA:HPRCFO (foam only)	HPRCLO708TSA-1 PADLOCK - TSA	HPRCBAG2700W INTERIOR BAG USA:HPRCIC (internal case)	HPRCORG2700W LID ORGANIZER	HPRCSSK2700W-01 SECOND SKIN	

HPRC 2710



* open cases images reflect the different HPRC cases internal options

TECHNICAL FEATURES

Dimension:

internal dimension 555x459x256(mm) - 21.85x18.07x10.08(in)
external dimension 617x525x280(mm) - 24.29x20.67x11.02(in)



lid: 45(mm) - 1.77(in) bottom: 211(mm) - 8.30(in)

Weight:

empty: 6.71kg - 14.76lbs

Temperature rating:

Minimum Maximum
-40°C -40°F +80°C +176°F

Colors:

Black

TECHNICAL DRAWING

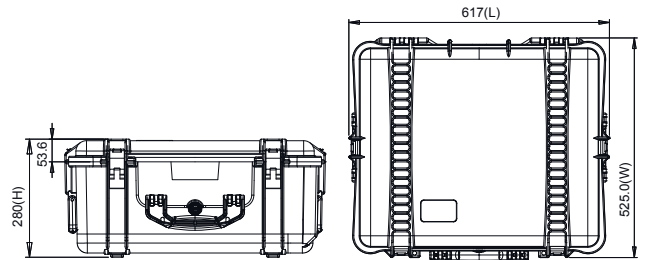

* cubed foam



APPROVALS
ATA 300
IP67
STANAG 4280
DS 81-41

TEST
DROP
IMPACT
HANDLE
WATERTIGHT INTEGRITY
UV COLOR AND MATERIAL
PROTECTION



ACCESSORIES

HPRCCUB2710
CUBED FOAM
USA:HPRCFO (foam only)

HPRCLO708TSA-1
PADLOCK - TSA

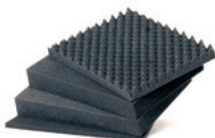

* open cases images reflect the different HPRC cases internal options

HPRC 2730W



TECHNICAL FEATURES

Dimension:

internal dimension 509x460x316(mm) - 20.04x18.11x12.44(in)
external dimension 620x520x350(mm) - 24.41x20.47x13.78(in)



lid: 45(mm) - 1.77(in) bottom: 271(mm) - 10.66(in)



Weight:

empty: 7,55kg - 16.64lbs
with cubed foam: 10,43kg - 22.99lbs

Temperature rating:

Minimum -40°C -40°F Maximum +80°C +176°F

Colors:

Black

TECHNICAL DRAWING

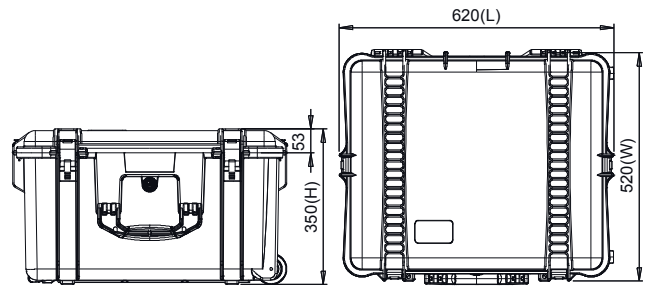

* cubed foam	* interior bag	* soft padded open deck + dividers	APPROVALS ATA 300 IP67 STANAG 4280 DS 81-41 TEST DROP IMPACT HANDLE WATERTIGHT INTEGRITY UV COLOR AND MATERIAL PROTECTION



ACCESSORIES

HPRCCUB2730W CUBED FOAM USA:HPRCFO (foam only)	HPRCLO708TSA-1 PADLOCK - TSA	HPRCBAG2730W INTERIOR BAG USA:HPRCIC (internal case)	HPRCORG2730W LID ORGANIZER	HPRCSFD2730W SOFT PADDED OPEN DECK + DIVIDERS USA: HPRCDK (divider kit)

HPRC 2760W



When innovation becomes a case

Main features:

- 4 built in wheels: roll the case along by simply pushing it while it's on the ground
- two side handles: push or pull the case as a trolley
- stackable exterior lid design: use the case as a cart by stacking more cases on top of each other
- two lateral handles: when you need to hold the case from both sides
- comfortable soft-grip handle
- braked wheels to prevent unexpected movement



HPRC 2760W

* open cases images reflect the different HPRC cases internal options



TECHNICAL FEATURES

Dimension:

internal dimension 690x450x300(mm) - 27.16x17.71x11.81(in)
external dimension 750x510x329(mm) - 29.53x20.08x12.99(in)

lt 91

lid: 50(mm) - 1.97(in) bottom: 250(mm) - 9.84(in)

W

Weight:

empty: 9,20kg - 20.28lbs
with cubed foam: 10,72kg - 23.63lbs

Temperature rating:

Minimum Maximum
-40°C -40°F +80°C +176°F

Colors:

Black

TECHNICAL DRAWING

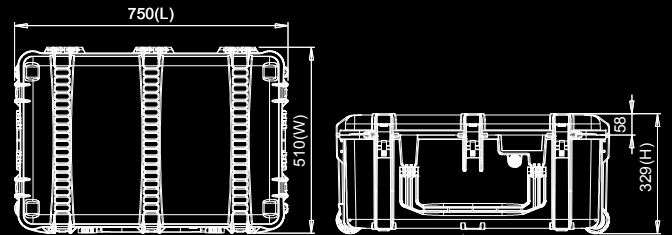

* cubed foam

* interior bag

* soft padded open deck + dividers



APPROVALS
ATA 300
IP67
STANAG 4280
DS 81-41

TEST
DROP
IMPACT
HANDLE
WATERTIGHT INTEGRITY
UV COLOR AND MATERIAL
PROTECTION

lt volume in litres

W

ACCESSORIES

HPRCCUB2760W

CUBED FOAM
USA:HPRCFO (foam only)

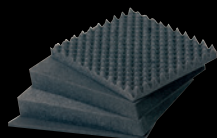

HPRCLO708TSA-1

PADLOCK - TSA



HPRCBAG2760W

Interior bag
USA:HPRCIC (internal case)



HPRCSFD2760W

SOFT PADDED
OPEN DECK + DIVIDERS USA:
HPRCDK (divider kit)



HPRC 2780W



* open cases images reflect the different HPRC cases internal options

TECHNICAL FEATURES

Dimension:
internal dimension 749x525x366(mm) - 29.49x20.67x14.41(in)
external dimension 810x586,5x388(mm) - 31.89x23.09x15.28(in)

lid: 73(mm) - 2.87(in) bottom: 293(mm) - 11.53(in)

Weight:
empty: 12,20kg - 26.90lbs
with cubed foam: 16,18kg - 35.67lbs

Temperature rating:
Minimum Maximum
-40°C -40°F +80°C +176°F

Colors:
Black



TECHNICAL DRAWING

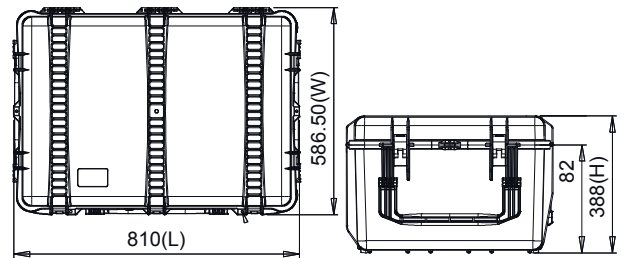

* cubed foam	* interior bag	* soft padded open deck + dividers	APPROVALS ATA 300 IP67 STANAG 4280 DS 81-41 TEST DROP IMPACT HANDLE WATERTIGHT INTEGRITY UV COLOR AND MATERIAL PROTECTION



ACCESSORIES

HPRCCUB2780W CUBED FOAM USA:HPRCFO (foam only)	HPRCLO708TSA-1 PADLOCK - TSA	HPRCBAG2780W INTERIOR BAG USA:HPRCIC (internal case)	HPRCORG2780W LID ORGANIZER	HPRCSFD2780W SOFT PADDED OPEN DECK + DIVIDERS USA: HPRCDK (divider kit)

HPRC 2800W

* open cases images reflect the different HPRC cases internal options



TECHNICAL FEATURES

Dimension:

internal dimension 749x525x455(mm) - 29.49x20.67x17.91(in)
external dimension 810x586,5x479(mm) - 31.89x23.09x18.86(in)



lid: 73(mm) - 2.87(in) bottom: 382(mm) - 15.03(in)



Weight:

empty: 13,20kg - 29.10lbs
with cubed foam: 17,43kg - 38.43lbs

Temperature rating:

Minimum -40°C -40°F Maximum +80°C +176°F

Colors:

Black

TECHNICAL DRAWING

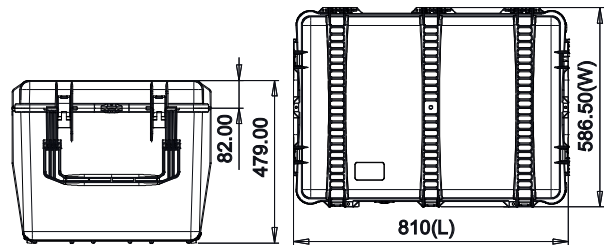

* cubed foam	* interior bag	* soft padded open deck + dividers	APPROVALS ATA 300 IP67 STANAG 4280 DS 81-41
			TEST DROP IMPACT HANDLE WATERTIGHT INTEGRITY UV COLOR AND MATERIAL PROTECTION
			volume in litres wheeled

ACCESSORIES

HPRCCUB2800W CUBED FOAM USA:HPRCFO (foam only)	HPRCLO708TSA-1 PADLOCK - TSA	HPRCBAG2800W INTERIOR BAG USA:HPRCIC (internal case)	HPRCORG2800W LID ORGANIZER	HPRCSFD800W SOFT PADDED OPEN DECK + DIVIDERS USA: HPRCDK (divider kit)

HPRC 3500



* open cases images reflect the different HPRC cases internal options

TECHNICAL FEATURES

Dimension:

internal dimension 433x319x169(mm) - 17.05x12.56x6.65(in)
external dimension 498x370x185(mm) - 19.61x14.57x7.28(in)

lid: 72(mm) - 2.83(in) bottom: 97(mm) - 3.81(in)

Weight:

empty: 3,00kg - 6.61lbs
with cubed foam: 3,55kg - 7.82lbs

Temperature rating:

Minimum Maximum
-40°C -40°F +80°C +176°F

Colors:

Black



TECHNICAL DRAWING

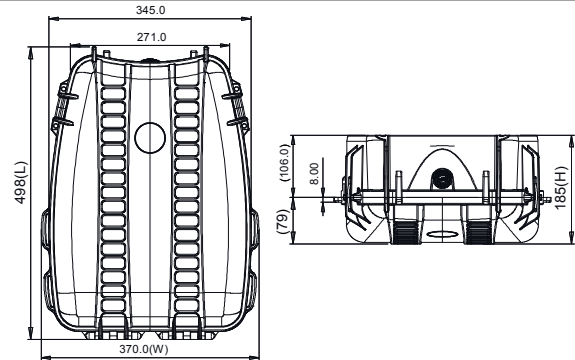

* cubed foam

* interior bag



APPROVALS
ATA 300
IP67
STANAG 4280
DS 81-41

TEST
DROP
IMPACT
HANDLE
WATERTIGHT INTEGRITY
UV COLOR AND MATERIAL
PROTECTION



ACCESSORIES

HPRCCUB3500
CUBED FOAM
USA:HPRCFO (foam only)



HPRCBAG3500
INTERIOR BAG
USA:HPRCIC (internal case)



HPRCORG3500
LID ORGANIZER



Photo by Octopus BE



HPRC 4050



* open cases images reflect the different HPRC cases internal options

TECHNICAL FEATURES

Dimension:

internal dimension 261x171x220(mm) - 10.28x6.73x8.66(in)
external dimension 284x223x260(mm) - 11.18x8.78x10.24(in)

lid: 24(mm) - 0.94(in) bottom: 196(mm) - 7.71(in)

Weight:

empty: 1,66kg - 3.66lbs
with cubed foam: 1,85kg - 4.07lbs

Temperature rating:

Minimum Maximum
-40°C -40°F +80°C +176°F

Colors:

Black



TECHNICAL DRAWING

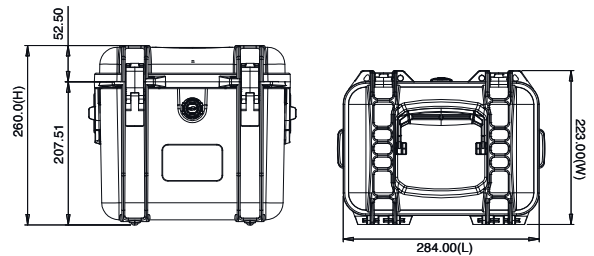

* cubed foam



* soft padded open deck + dividers



APPROVALS
ATA 300
IP67
STANAG 4280
DS 81-41

TEST
DROP
IMPACT
HANDLE
WATERTIGHT INTEGRITY
UV COLOR AND MATERIAL
PROTECTION



ACCESSORIES

HPRCCUB4050
CUBED FOAM
USA:HPRCFO (foam only)

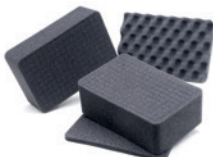

HPRCLO708TSA-1
PADLOCK - TSA



HPRCPADDEDSTRAP



HPRCSFD4050 SOFT PADDED
OPEN DECK + DIVIDERS USA:
HPRCDK (divider kit)



HPRCPANELFRAME
SUPPORT KIT



* open cases images reflect the different HPRC cases internal options



TECHNICAL FEATURES

Dimension:

internal dimension 401x231x231(mm) - 15.79x9.09x9.09(in)
external dimension 424x284x276,5(mm) - 16.69x11.18x10.89(in)

lid: 46(mm) - 1.81(in) bottom: 185(mm) - 7.28(in)

Weight:

empty: 2,78kg - 6.13lbs
with cubed foam: 3,27kg - 7.20lbs

Temperature rating:

Minimum -40°C -40°F Maximum +80°C +176°F

Colors:

Black



TECHNICAL DRAWING

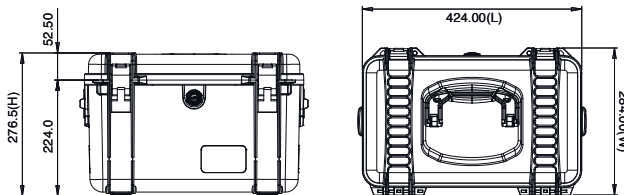

APPROVALS
ATA 300
IP67
STANAG 4280
DS 81-41

TEST
DROP
IMPACT
HANDLE
WATERTIGHT INTEGRITY
UV COLOR AND MATERIAL
PROTECTION



* cubed foam

* soft padded open deck + dividers

ACCESSORIES

HPRCCUB4100
CUBED FOAM
USA:HPRCFO (foam only)

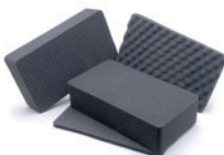

HPRCLO708TSA-1
PADLOCK - TSA



HPRCPADDEDSTRAP



HPRCSFD4100 SOFT PADDED
OPEN DECK + DIVIDERS USA:
HPRCDK (divider kit)



HPRCPANELFRAME
SUPPORT KIT



HPRC 4200

**SHOULDER
CASE**



* open cases images reflect the different HPRC cases internal options

TECHNICAL FEATURES

Dimension:
internal dimension 460x240x400(mm) - 18.11x9.45x15.75(in)
external dimension 483x293x445,5(mm) - 19.02x11.54x17.54(in)

lt44

lid: 66(mm) - 2.60(in) bottom: 334(mm) - 13.14(in)

Weight:
empty: 5,00kg - 11.02lbs
with cubed foam: 6,03kg - 13.29lbs

Temperature rating:
Minimum -40°C -40°F Maximum +80°C +176°F

Colors:
Black

TECHNICAL DRAWING

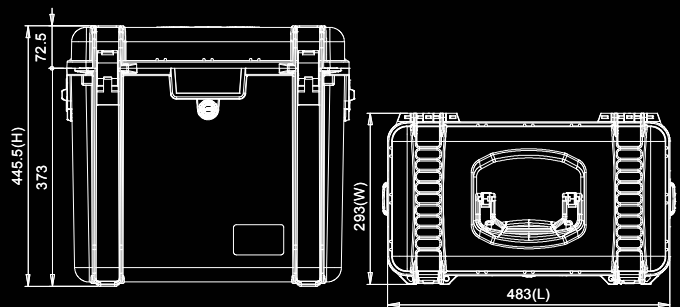

* cubed foam * interior bag soft padded open deck + dividers



APPROVALS
ATA 300
IP67
STANAG 4280
DS 81-41

TEST
DROP
IMPACT
HANDLE
WATERTIGHT INTEGRITY
UV COLOR AND MATERIAL
PROTECTION

lt volume in litres
W wheeled

ACCESSORIES

<p>HPRCCUB4200 CUBED FOAM USA:HPRCFO (foam only)</p>	<p>HPRCLO708TSA-1 PADLOCK - TSA</p>	<p>HPRCCBAG4200 INTERIOR BAG USA:HPRCIC (internal case)</p>	<p>HPRCPADEDSTRAP</p>	<p>HPRCSFD4200 SOFT PADDED OPEN DECK + DIVIDERS USA: HPRCDK (divider kit)</p>	<p>HPRCPANELFRAME SUPPORT KIT</p>

HPRC 4300

* open cases images reflect the different HPRC cases internal options



TECHNICAL FEATURES

Dimension:

internal dimension 585x320x309(mm) - 23.03x12.60x12.17(in)
external dimension 690x380x355(mm) - 27.17x14.96x13.98(in)



lid: 80(mm) - 3.15(in) bottom: 229(mm) - 9.01(in)

Weight:

empty: 6,50kg - 14.33lbs
with cubed foam: 7,96kg - 17.54lbs

Temperature rating:

Minimum Maximum
-40°C -40°F +80°C +176°F

Colors:

Black

TECHNICAL DRAWING

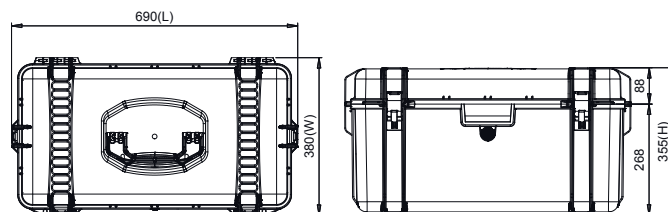

* cubed foam	* interior bag	* soft padded open deck + dividers	APPROVALS ATA 300 IP67 STANAG 4280 DS 81-41 TEST DROP IMPACT HANDLE WATERTIGHT INTEGRITY UV COLOR AND MATERIAL PROTECTION



ACCESSORIES

HPRCCUB4300 CUBED FOAM USA:HPRCFO (foam only)	HPRCLO708TSA-1 PADLOCK - TSA	HPRCBAG4300 INTERIOR BAG USA:HPRCIC (internal case)	HPRCSFD4300 SOFT PADDED OPEN DECK + DIVIDERS USA: HPRCDK (divider kit)

HPRC 4300W



* open cases images reflect the different HPRC cases internal options

TECHNICAL FEATURES

Dimension:

internal dimension 585x320x300(mm) - 23.03x12.60x11.81(in)
external dimension 690x380x358(mm) - 27.17x14.96x14.09(in)

62
lt

lid: 80(mm) - 3.15(in) bottom: 220(mm) - 8.66(in)

W

Weight:

empty: 7,30kg - 16.09lbs
with cubed foam: 8,76kg - 19.31lbs

Temperature rating:

Minimum Maximum
-40°C -40°F +80°C +176°F

Colors:

Black

TECHNICAL DRAWING

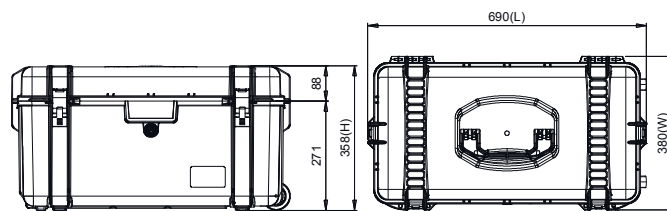

* cubed foam



* interior bag



* soft padded open deck + dividers



APPROVALS
ATA 300
IP67
STANAG 4280
DS 81-41

TEST
DROP
IMPACT
HANDLE
WATERTIGHT INTEGRITY
UV COLOR AND MATERIAL
PROTECTION

volume in litres

62

wheeled

ACCESSORIES

HPRCCUB4300W
CUBED FOAM
USA:HPRCF0 (foam only)



HPRCLO708TSA-1
PADLOCK - TSA



HPRCBAG4300W
INTERIOR BAG
USA:HPRCIC (internal case)



HPRCSFD4300W SOFT PADDED
OPEN DECK + DIVIDERS USA:
HPRCDK (divider kit)



HPRC 4400

* open cases images reflect the different HPRC cases internal options



TECHNICAL FEATURES

Dimension:

internal dimension 420x420x389(mm) - 16.54x16.54x15.31(in)
external dimension 479x481x437(mm) - 18.86x18.94x17.20(in)

lit 74

lid: 65(mm) - 2.56(in) bottom: 324(mm) - 12.75(in)

Weight:

empty: 6,70kg - 14.77lbs
with cubed foam: 8,90kg - 19.62lbs

Temperature rating:

Minimum Maximum
-40°C -40°F +80°C +176°F

Colors:

Black

TECHNICAL DRAWING

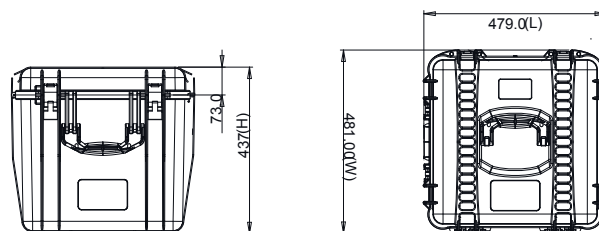

* cubed foam



APPROVALS
ATA 300
IP67
STANAG 4280
DS 81-41

TEST
DROP
IMPACT
HANDLE
WATERTIGHT INTEGRITY
UV COLOR AND MATERIAL
PROTECTION

volume in litres
wheeled

ACCESSORIES

HPRCCUB4400
CUBED FOAM
USA:HPRCFO (foam only)

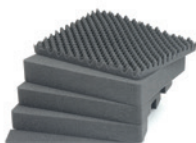

HPRCLO708TSA-1
PADLOCK - TSA



HPRCKITW4400
wheel kit for 4400



HPRC 4600W



* open cases images reflect the different HPRC cases internal options

TECHNICAL FEATURES

Dimension:

internal dimension 611x611x375(mm) - 24.05x24.05x14.76(in)
external dimension 670x677x418.5(mm) - 26.38x26.65x16.4(in)



lid: 85.5(mm) - 3.36(in) bottom: 289(mm) - 11.37(in)

Weight:

empty: 10,7kg - 23.54lbs



Temperature rating:

Minimum -40°C -40°F Maximum +80°C +176°F

Colors:

Black

TECHNICAL DRAWING

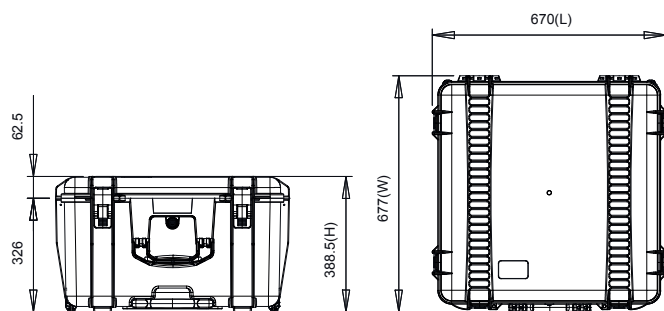

* cubed foam



APPROVALS
ATA 300
IP67
STANAG 4280
DS 81-41

TEST
DROP
IMPACT
HANDLE
WATERTIGHT INTEGRITY
UV COLOR AND MATERIAL
PROTECTION

volume in litres



ACCESSORIES

HPRCCUB4600W
CUBED FOAM
USA:HPRCFO (foam only)



HPRCLO708TSA-1
PADLOCK - TSA





HPRC 4700W



* open cases images reflect the different HPRC cases internal options

TECHNICAL FEATURES

Dimension:

internal dimension 508x301x497(mm) - 20.00x11.85x19.57(in)
external dimension 572x412x564(mm) - 22.52x16.22x22.20(in)



lid: 23(mm) - 0.91(in) bottom: 474(mm) - 18.66(in)



Weight:

empty: 11,60kg - 25,57lbs
with cubed foam: 14,84kg - 32,71lbs

Temperature rating:

Minimum Maximum
-40°C -40°F +80°C +176°F

Colors:

Black

TECHNICAL DRAWING

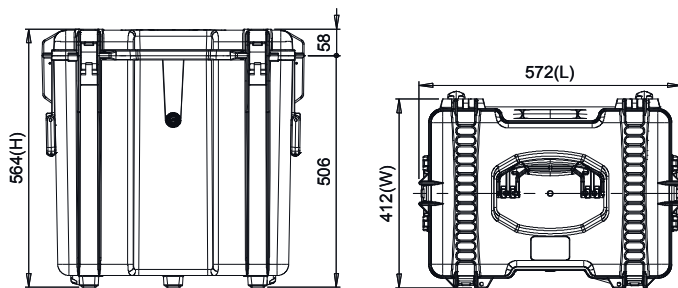

* cubed foam



* interior bag



APPROVALS
ATA 300
IP67
STANAG 4280
DS 81-41

TEST
DROP
IMPACT
HANDLE
WATERTIGHT INTEGRITY
UV COLOR AND MATERIAL
PROTECTION



ACCESSORIES

HPRCCUB4700W
CUBED FOAM
USA:HPRCFO (foam only)



HPRCLO708TSA-1
PADLOCK - TSA



HPRCBAG4700W
Interior bag
USA:HPRCIC (internal case)



HPRC 4800W

* open cases images reflect the different HPRC cases internal options



TECHNICAL FEATURES

Dimension:

internal dimension 720x320x600(mm) - 28.34x12.60x23.62(in)
external dimension 776x380x649(mm) - 30.55x14.96x25.55(in)

lid: 60(mm) - 2.36(in) bottom: 540(mm) - 21.25(in)

Weight:

empty: 10,00kg - 22.21lbs
with cubed foam: 14,10kg - 31.08lbs

Temperature rating:

Minimum Maximum
-40°C -40°F +80°C +176°F

Colors:

Black



TECHNICAL DRAWING

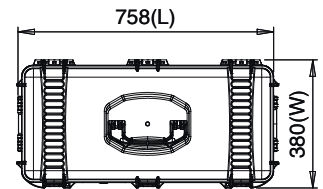
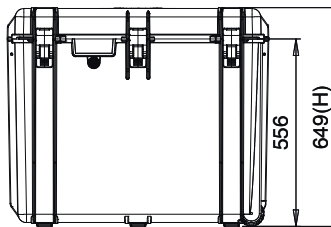

* cubed foam



* interior bag



APPROVALS
ATA 300
IP67
STANAG 4280
DS 81-41

TEST
DROP
IMPACT
HANDLE
WATERTIGHT INTEGRITY
UV COLOR AND MATERIAL
PROTECTION



ACCESSORIES

HPRCCUB4800W
CUBED FOAM
USA:HPRCFO (foam only)



HPRCLO708TSA-1
PADLOCK - TSA



HPRCBAG4800W
Interior bag
USA:HPRCIC (internal case)





HPRC 5400W

* open cases images reflect the different HPRC cases internal options



TECHNICAL FEATURES

Dimension:

internal dimension 1140x350x160(mm) - 44.88x13.78x6.30(in)
external dimension 1175x410x181(mm) - 46.26x16.14x7.13(in)



lid: 45(mm) - 1.77(in) bottom: 115(mm) - 4.52(in)



Weight:

empty: 7,90kg - 17.42lbs
with cubed foam: 8,80kg - 19.40lbs

Temperature rating:

Minimum Maximum
-40°C -40°F +80°C +176°F

Colors:

Black

TECHNICAL DRAWING

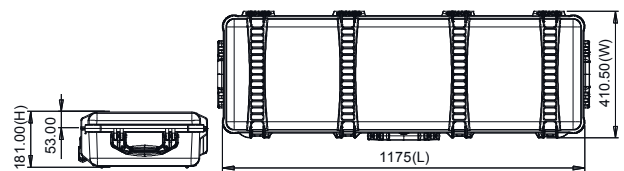

APPROVALS
ATA 300
IP67
STANAG 4280
DS 81-41

TEST
DROP
IMPACT
HANDLE
WATERTIGHT INTEGRITY
UV COLOR AND MATERIAL
PROTECTION



* cubed foam

* interior bag

ACCESSORIES

HPRCCUB5400W
CUBED FOAM
USA:HPRCFO (foam only)



HPRCLO708TSA-1
PADLOCK - TSA



HPRCBAG5400W
INTERIOR BAG
USA:HPRCIC (internal case)



HPRC 6200



* open cases images reflect the different HPRC cases internal options

TECHNICAL FEATURES

Dimension:

internal dimension 651x279x243(mm) - 25.63x10.98x9.57(in)
external dimension 700x335x292(mm) - 27.56x13.19x11.50(in)

lit 38

lid: 112(mm) - 4.41(in) bottom: 131(mm) - 5.15(in)

Weight:

empty: 4,00kg - 8.82lbs
with cubed foam: 5,80kg - 12.78lbs

Temperature rating:

Minimum Maximum
-40°C -40°F +80°C +176°F

Colors:

Black

TECHNICAL DRAWING

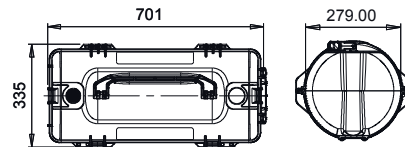

<p>* cubed foam</p>	<p>* tri version</p>		<p>APPROVALS ATA 300 IP67 STANAG 4280 DS 81-41</p> <p>TEST DROP IMPACT HANDLE WATERTIGHT INTEGRITY UV COLOR AND MATERIAL PROTECTION</p> <p>volume in litres 38 wheeled</p>
---------------------	----------------------	--	---

ACCESSORIES

<p>HPRCCUB6200 CUBED FOAM USA:HPRCFO (foam only)</p>	<p>HPRCTRI6200-02 for tripods</p>	<p>HPRCLO708TSA-1 PADLOCK - TSA</p>
---	--	--

HPRC 6300W



* open cases images reflect the different HPRC cases internal options

TECHNICAL FEATURES

Dimension:

internal dimension 921x279x243(mm) - 36.26x10.98x9.57(in)
external dimension 970x335x285(mm) - 38.19x13.19x11.22(in)

lit 54

lid: 112(mm) - 4.41(in) bottom: 131(mm) - 5.15(in)

W

Weight:

empty: 5,70kg - 12.57lbs
with cubed foam: 6,95kg - 15.32lbs

Temperature rating:

Minimum Maximum
-40°C -40°F +80°C +176°F

Colors:

Black

TECHNICAL DRAWING

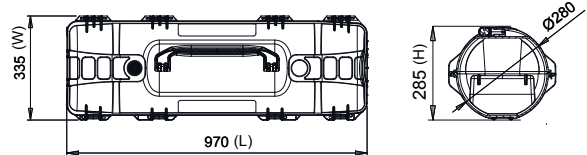

* cubed foam

* tri version



APPROVALS
ATA 300
IP67
STANAG 4280
DS 81-41

TEST
DROP
IMPACT
HANDLE
WATERTIGHT INTEGRITY
UV COLOR AND MATERIAL
PROTECTION

volume in litres
lit 54
wheeled

ACCESSORIES

HPRC6300W
CUBED FOAM
USA: HPRCFO (foam only)



HPRCTRIKIT-02
for tripods



HPRCLO708TSA-1
PADLOCK - TSA



HPRC 6400W



* open cases images reflect the different HPRC cases internal options

TECHNICAL FEATURES

Dimension:

internal dimension 1081x279x243(mm) - 42.56x10.98x9.57(in)
external dimension 1128x335x258(mm) - 44.41x13.19x11.22(in)

lid: 112(mm) - 4.41(in) bottom: 131(mm) - 5.15(in)

Weight:

empty: 6,30kg - 13.89lbs
with cubed foam: 7,84kg - 17.28lbs

Temperature rating:

Minimum Maximum
-40°C -40°F +80°C +176°F

Colors:

Black

lit64

W

TECHNICAL DRAWING

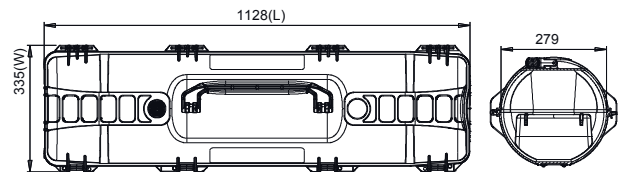

* cubed foam

* tri version



APPROVALS
ATA 300
IP67
STANAG 4280
DS 81-41

TEST
DROP
IMPACT
HANDLE
WATERTIGHT INTEGRITY
UV COLOR AND MATERIAL
PROTECTION

volume in litres
wheeled

ACCESSORIES

HPRCCUB6400W
CUBED FOAM
USA:HPRCFO (foam only)



HPRCTRIKIT-02
for tripods



HPRCLO708TSA-1
PADLOCK - TSA



HPRC 6500W



* open cases images reflect the different HPRC cases internal options

TECHNICAL FEATURES

Dimension:

internal dimension 1281x279x243(mm) - 50.43x10.98x9.57(in)
external dimension 1330x335x285(mm) - 52.36x13.19x11.22(in)

lit 76

lid: 112(mm) - 4.41(in) bottom: 131(mm) - 5.15(in)

Weight:

empty: 7,20kg - 15.87lbs
with cubed foam: 9,03kg - 19.90lbs

W

Temperature rating:

Minimum Maximum
-40°C -40°F +80°C +176°F

Colors:

Black

TECHNICAL DRAWING

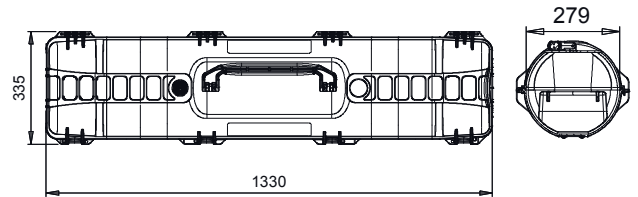

* cubed foam

* tri version



APPROVALS
ATA 300
IP67
STANAG 4280
DS 81-41

TEST
DROP
IMPACT
HANDLE
WATERTIGHT INTEGRITY
UV COLOR AND MATERIAL
PROTECTION

volume in litres
wheeled

ACCESSORIES

HPRCCUB6500W
CUBED FOAM
USA:HPRCFO (foam only)



HPRCTRIKIT-02
for tripods



HPRCLO708TSA-1
PADLOCK - TSA







TECHNICAL FEATURES

Dimension:

closed 394x280x27,5(mm) - 15.51x11.02x1.08(in)
open 464x350x27,5(mm) - 18.26x13.77x1.08(in)

Weight:

empty: 0,95kg - 2.09lbs

Temperature rating:

Minimum -40°C -40°F Maximum +80°C +176°F

Colors:

Black

TECHNICAL DRAWING

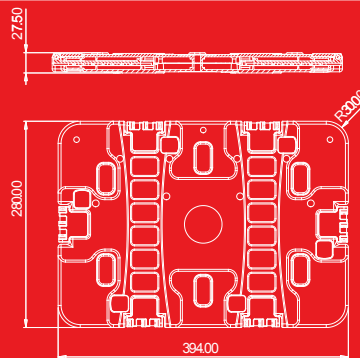

* tripod, laptop and schelster not included



APPROVALS
ATA 300
IP67
STANAG 4280
DS 81-41

TEST
DROP
IMPACT
HANDLE
WATERTIGHT INTEGRITY
UV COLOR AND MATERIAL
PROTECTION



technical chart

HPRC1100



internal dimension
57x58x25,5(mm)
2.24x2.28x1.00(in)



external dimension
69x80x32(mm)
2.72x3.15x1.26(in)

weight empty
empty: 0,04kg - 0.09lbs

Colors
Black - Ferrari red

HPRC1300



internal dimension
116x67x25.5(mm)
4.57x2.64x1.00(in)



external dimension
127x90x32(mm)
5.00x3.54x1.26(in)

weight empty
empty: 0,09kg - 0.19lbs

Colors
Black - Ferrari red

HPRC2100



internal dimension
210x145x94(mm)
8.27x5.71x3.70(in)



external dimension
235x196x110(mm)
9.25x7.72x4.33(in)

weight empty
empty: 0,76kg - 1.68lbs

Colors
Black - Orange - Ferrari red -
Electric blue

HPRC2200



internal dimension
236x182x108(mm)
9.29x7.17x4.25(in)



external dimension
258x230x123(mm)
10.16x9.06x4.84(in)

weight empty
empty: 0,87kg - 1.92lbs

Colors
Black

HPRC2250



internal dimension
236x182x155(mm)
9.29x7.17x6.10(in)



external dimension
258x230x170(mm)
10.16x9.06x6.69(in)

weight empty
1,00kg - 2.20lbs

Colors
Black

HPRC2300



internal dimension
304x231x137(mm)
11.97x9.09x5.39(in)



external dimension
335x289x155(mm)
13.19x11.38x6.10(in)

weight empty
1,67kg - 3.68lbs

Colors
Black - Orange - Ferrari red -
Electric blue

HPRC2350



internal dimension
340x235x99(mm)
13.38x9.25x3.90(in)



external dimension
365x290x115(mm)
-14.37x11.42x4.53(in)

weight empty
1.48kg - 3.25lbs



Colors
Black

HPRC2400



internal dimension
380x266x152(mm)
14.96x10.47x5.98(in)



external dimension
405x330x170(mm)
15.94x12.99x6.69(in)

weight empty
2,05kg - 4.52lbs



Colors
Black - Orange - Ferrari red -
Electric blue

HPRC2460



internal dimension
409x306x175(mm)
16.10x12.05x6.89(in)



external dimension
434x371x193(mm)
17.09x14.61x7.60(in)

weight empty
2,60kg - 5.73lbs

Colors
Black

HPRC2500



internal dimension
450x323x175(mm)
17.72x12.72x6.89(in)



external dimension
478x390x194(mm)
18.82x15.35x7.64(in)

weight empty
3,15kg - 6.94lbs



Colors
Black - Orange - Ferrari red -
Electric blue

HPRC2530



internal dimension
513x288x132(mm)
20.20x11.34x5.20(in)



external dimension
540x350x153(mm)
21.26x13.78x6.02(in)

weight empty
3,20kg - 7.05lbs

Colors
Black

HPRC2550W



internal dimension
513x288x200(mm)
20.19x11.34x7.87(in)



external dimension
549x346x236(mm)
21.61x13.62x9.29(in)

weight empty
4,35kg - 9.57lbs



Colors
Black - Orange -
Ferrari red -
Electric blue

NEW

HPRC2580 



internal dimension
390x310x89(mm)
15.35x12.20x3.50(in)

external dimension
410x359x110(mm)
16.14x14.13x4.33(in)

weight empty
2,40kg - 5.29lbs

Colors
Black

lt11

HPRC2600 



internal dimension
492x366x202(mm)
19.37x14.41x7.95(in)

external dimension
555x432x223(mm)
21.85x17.01x8.78(in)

weight empty
4,25kg - 9.37lbs

Colors
Black - Orange - Ferrari red -
Electric blue

lt34

HPRC2600W 



internal dimension
482x358x218(mm)
18.98x14.09x8.58(in)

external dimension
546x423x250(mm)
21.05x16.65x9.84(in)

weight empty
6,05kg - 13.34lbs

Colors
Black - Orange - Electric blue

lt38

W

HPRC2700 



internal dimension
555x459x205(mm)
21.85x18.07x8.07(in)

external dimension
617x525x227(mm)
24.29x20.67x8.94(in)

weight empty
5,55kg - 12.24lbs

Colors
Black - Orange - Ferrari red

lt52

HPRC2700W 



internal dimension
555x459x256(mm)
21.85x18.07x10.08(in)

external dimension
620x525x280(mm)
24.41x20.67x11.02(in)

weight empty
8,30kg - 18.30lbs

Colors
Black - Orange - Ferrari red

lt65

W

HPRC2710 



internal dimension
555x459x256(mm)
21.85x18.07x10.08(in)

external dimension
617x525x280(mm)
24.29x20.67x11.02(in)

weight empty
6.71kg - 14.76lbs

Colors
Black

lt64

HPRC2730W 



internal dimension
509x460x316(mm)
20.04x18.11x12.44(in)

external dimension
620x520x350(mm)
24.41x20.47x13.78(in)

weight empty
7,55kg - 16.64lbs

Colors
Black

lt72

W

HPRC2760W 



internal dimension
690x450x300(mm)
27.16x17.71x11.81(in)

external dimension
750x510x329(mm)
29.53x20.08x12.99(in)

weight empty
9,20kg - 20.28lbs

Colors
Black

lt91

W

HPRC2780W 



internal dimension
749x525x366(mm)
29.49x20.67x14.41(in)

external dimension
810x586,5x388(mm)
31.89x23.09x15.28(in)

weight empty
12,20kg - 26.90lbs

Colors
Black

lt142

W

HPRC2800W 



internal dimension
749x525x455(mm)
29.49x20.67x17.91(in)

external dimension
810x586,5x479(mm)
31.89x23.09x18.86(in)

weight empty
13,20kg - 29.10lbs

Colors
Black

lt179

W

HPRC3500 



internal dimension
433x319x169(mm)
17.05x12.56x6.65(in)

external dimension
498x370x185(mm)
19.61x14.57x7.28(in)

weight empty
3,00kg - 6.61lbs

Colors
Black

lt22

HPRC4050 



internal dimension
261x171x220(mm)
10.28x6.73x8.66(in)

external dimension
284x223x260(mm)
11.18x8.78x10.24(in)

weight empty
3,00kg - 6.61lbs

Colors
Black

lt10

CABIN OK

technical chart

HPRC4100			internal dimension 401x231x231(mm) 15.79x9.09x9.09(in)
	external dimension 424x284x276,5(mm) 16.69x11.18x10.89(in)		weight empty 2,78kg - 6.13lbs Colors Black
HPRC4200			internal dimension 460x240x400(mm) 18.11x9.45x15.75(in)
	external dimension 483x293x445,5(mm) 19.02x11.54x17.54(in)		weight empty 5,35kg - 11.79lbs Colors Black
HPRC4300			internal dimension 585x320x309(mm) 23.03x12.60x12.17(in)
	external dimension 690x380x355(mm) 27.17x14.96x13.98(in)		weight empty 6,50kg - 14.33lbs Colors Black
HPRC4300W			internal dimension 585x320x300(mm) 23.03x12.60x11.81(in)
	external dimension 690x380x358(mm) 27.17x14.96x14.09(in)		weight empty 7,30kg - 16.09lbs Colors Black
HPRC4400			internal dimension 420x420x389(mm) 16.54x16.54x15.31(in)
	external dimension 479x481x437(mm) 18.86x18.94x17.20(in)		weight empty 6,70kg - 14.77lbs Colors Black
HPRC4600W			internal dimension 611x611x375(mm) 24.05x24.05x14.76(in)
	external dimension 670x677x418,5(mm) 26.38x26.65x16.4(in)		weight empty 9,9kg - 21.83lbs Colors Black
HPRC4700W			internal dimension 508x301x497(mm) 20.00x11.85x19.57(in)
	external dimension 572x412x564(mm) 22.52x16.22x22.20(in)		weight empty 11,60kg - 25.57lbs Colors Black
HPRC4800W			internal dimension 720x320x600(mm) 28.34x12.60x23.62(in)
	external dimension 776x380x649(mm) 30.55x14.96x25.55(in)		weight empty 10,00kg - 22.21lbs Colors Black
HPRC5400W			internal dimension 1140x350x160(mm) 44.88x13.78x6.30(in)
	external dimension 1175x410x181(mm) 46.26x16.14x7.13(in)		weight empty 7,90kg - 17.42lbs Colors Black

Discover all our products
at: www.hprc.it

HPRC6200

internal dimension
651x279x243(mm)
25.63x10.98x9.57(in)



external dimension
700x335x292(mm)
27.56x13.19x11.50(in)

weight empty
4,00kg - 8.82lbs

Colors
Black

HPRC6300W

internal dimension
921x279x243(mm)
36.26x10.98x9.57(in)



external dimension
970x335x285(mm)
38.19x13.19x11.22(in)

weight empty
5,70kg - 12.57lbs

Colors
Black

**HPRC6400W**

internal dimension
1081x279x243(mm)
42.56x10.98x9.57(in)



external dimension
1128x335x258(mm)
44.41x13.19x11.22(in)

weight empty
6,30kg - 13.89lbs

Colors
Black

**HPRC6500W**

internal dimension
1281x279x243(mm)
50.43x10.98x9.57(in)



external dimension
1330x335x285(mm)
52.36x13.19x11.22(in)

weight empty
7,20kg - 15.87lbs

Colors
Black

**HPRC0500**

dimension closed
394x280x27,5(mm)
15.51x11.02x1.08(in)

dimension open
464x350x27,5(mm)
18.26x13.77x1.08(in)

weight empty
empty: 0,95kg - 2.09lbs

Colors
Black

Plaber S.r.l reserves the right to modify its products at any time and without notice, in order to better their quality and functionality. Therefore, all the information given in this datasheet is to be considered indicative and subject to possible modifications.



Photo by Roba Da Local



Photo by Flavio Oliva



Photo by Davide Marcesini



Photo by



H P R C C A S E S
MADE IN ITALY
M A N U F A C T U R E D

 Find us
on Facebook

 Plabertalia
Channel



HPRC[®]

Plaber s.r.l. - HPRC cases

Via Div Tridentina, 10
I-36061 Bassano del Grappa
Vicenza - Italy

Tel +39 0424 809150
Fax +39 0424 808548

USA office and warehouse:

Plaber America Inc - HPRC cases

240 Anderson Avenue
07074 Moonachie - New Jersey

Tel +1 201 617 2010
Fax +1 201 617 2001

www.hprc.it | www.hprcusa.com
info@hprc.it

HPRC[®] Brand owned by:

plaber
I T A L I A